



OUTDOOR SOLAR SYSTEMS

# BRUSTOR PERGOLAS

[WWW.SUNONBLINDS.COM](http://WWW.SUNONBLINDS.COM)

SUNON. SPACE, LIGHT AND SHADE.



ENGLISH

# WHY SUNON BLINDS?

More than 25 years ago, Sunon was born, a company formed by experienced personnel focused on the sector, since January 1993, we stand out for the wide range of solutions that we can provide. Sunon has professional collaborators from various sectors, such as: architects, engineers, window manufacturers, curtain wall manufacturers, and builders who provide the right systems for the execution of the project; for this reason, the company is recognized as one of the best in the industry

for the quality of their work. We ensure that in each project we eliminate any type of openings and gaps, in addition to providing a high design facade, comfortable, energy-saving, and environmentally friendly. We specialize in technical and adjustable shutter systems, with dynamic elements for residential sun protection, facades, security, and tunnel boxes, as well as motorization systems. Likewise, we also take care of product manufacturing, distribution and installation.

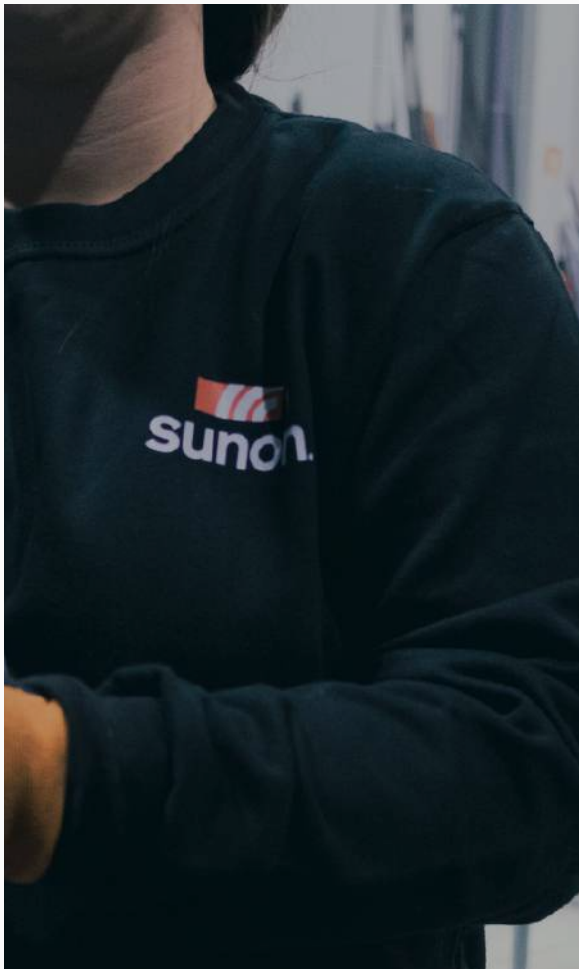

## BRUSTOR PERGOLAS

Sunon is present in all phases of the project. From advice to architects, to customized solutions for any type of renovation.

As a customer, through a virtual test, you can visualize the variety of options according to your project.

We will provide you with a technical and economic study where the total service will be provided, which includes: products, assembly, consulting and after-sales maintenance.

# SUN PROTECTION

## B 24 ELITE

## B 24 PRESTIGE

If you are looking for blinds that can take a beating, the B24 Elite and certainly the B24 Prestige are ideal. The latter is 6 Beaufort wind strength and offers you shade and shelter from various weather conditions.

The B24 Elite and the B24 Prestige are equipped with powerful articulated arms with 4 steel cables, which provide a range of shade up to a maximum of 3.75m. In addition to comfort, these awnings also create ambience. How about optional LED lighting and patio heating?

- Elegant finish with aluminium side panels without visible screws
- Enclosed enclosure for optimum protection in various weather conditions
- Maximum width of 7 m and linked

### B 24 ELITE

- 4 cables on the arms
- Extension up to 3.75 m
- Option: LED strip in the upper and lower arms or under the cabinet

### B 24 PRESTIGE

- The most robust solution
- Projection up to 3.75 m
- Option: LED spotlight in the elbow of the arm or underneath the enclosure

## PHOTOGRAPHIES:



# SUN PROTECTION

## B 2 5

### B 2 5 ELITE

### B 2 5 PRESTIGE

The B25 family is available in 3 different versions. U also have the option of a fully automatic steering wheel added on the B25 Prestige. With its compact design on any facade.

- Elegant finish with aluminium side panels without visible screws.
- Maximum width of 14 m thanks to the coupling of 2 awnings.
- Fully enclosed cassette
- Compact design

## B 2 5

- 2 cables on articulated arms
- Extension up to 3 m
- Option: LED strip under the enclosure

## B 2 5 ELITE

- 4 cables on the arms
- Extension up to 3.75 m
- Option: LED strip on upper and lower arms or LED strip under the enclosure
- Option: Motorised handwheel

## B 2 5 PRESTIGE

- 4 wires and forged elbow
- The most robust solution
- Projection up to 3.75 m
- Option: LED spotlight in the arm bracket or LED strip under the enclosure
- Option: Motorised handwheel

## PHOTOGRAPHIES:



# SUN PROTECTION

## B 27

### B 27 ELITE

### B 27 PRESTIGE

The B27 Standard, Elite and Prestige have a sleek, architectural design that is particularly suited to modern homes. for modern homes. You can even have them integrated into the façade. The technical specifications are identical to those of the namesake models B24 and B25 in Prestige, Elite and the standard version. We supply these awnings in 5 standard colours, but you can choose from 200 other RAL colours, so you are sure to find the colour you dream of.

- Contemporary, rectangular design
- Can be integrated into the façade
- Elegant finish with aluminium side panels without visible screws

## B 27

- 2 cables on articulated arms
- Extension up to 3 m
- Option: LED strip under the cabinet

## B 27 ELITE

- 4 cables on the arms
- Extension up to 3.75 m
- Option: LED strip in the upper and lower arms or under the cabinet

## B 27 PRESTIGE

- The most robust solution
- Forged elbow
- Option: LED spotlight in the arm bend or LED strip under the enclosure

## PHOTOGRAPHIES:

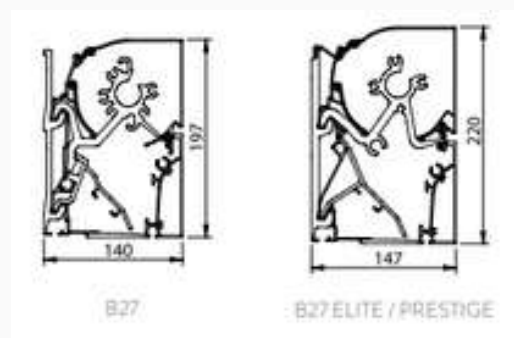

# SUN PROTECTION

## B 3 5

### B 3 5 PRESTIGE

The B35 and the B35 Prestige are very wind resistant awnings. The Prestige can even withstand up to 6 Beaufort, with a projection of up to 4 metres.

If you are looking for a large, wind resistant awning, the B35 (Prestige) is ideal. The B35 Prestige is designed as a three-tube system that complies with the highest European CE wind resistance standard (EN 13561). These articulated awnings can withstand wind forces of up to 6 Beaufort with a projection of up to 4 m, even with a 15 m single-sided fabric. Underneath, you can sit very comfortably even in strong winds. Optionally, this awning is equipped with LED lighting and electric heating. As an alternative to the 5 standard colours, you can choose from 200 optional RAL colours, which can be combined with hundreds of acrylic fabrics.

- Powerful articulated arms with 4 cables
- Three-pipe system with reinforced support tube
- Maximum width of 15 m due to coupling of 2 articulated arms
- Up to 4 m projection
- The "heavy duty" articulated arm

## B 3 5

- Standard gutter profile provides better fabric roll support
- Option: LED strip on the upper and lower arm or under the cabinet

## B 3 5 PRESTIGE

- Standard with Somfy RTS or IO motor with remote control
- Option: LED spotlight in the elbow of the arm or under the enclosure

## PHOTOGRAPHIES:

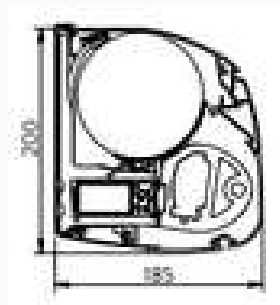
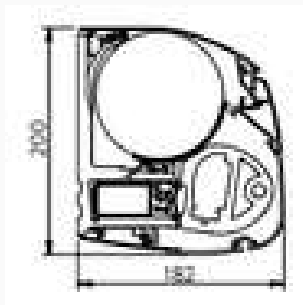

# SUN PROTECTION

## B 5 0

### B 5 0 XL

The B50 is a compact, fully enclosed cassette awning that stands out both aesthetically and technically. The Brustor B50 is available up to 5.50 m wide. The maximum projection is 3 m. The maximum projection is 3 m. Mounting is done by simply attaching the screen to the wall or ceiling bracket. With an adjustment nut, you can easily change the inclination of the screen from 0° to 45°. from 0° to 45°. This blind is optionally available with awning and heating.

New generation of articulated blinds with extra robustness awning box and LED strip in the box. The Brustor B50 XL is the big brother of the compact B50. Thanks to the more robust armoured box, the B50 XL is available up to 6 m wide and has a maximum projection of 3.50 m. The B50 XL has a maximum projection of 3.50 m. Do you want to add even more ambience? Then add optional LED lighting on the arms or integrated in the integrated awning box.

## B 5 0

- Awning up to 5.5 m wide
- Easy mounting with wall or ceiling bracket

## B 5 0 XL

- Extra robust enclosure
- Easy mounting with wall or ceiling bracket
- Max. 6 x 3 m or 5,50 x 3,50 m
- Optional LED on the arms or in the cabinet

## PHOTOGRAPHIES:

### B 5 0

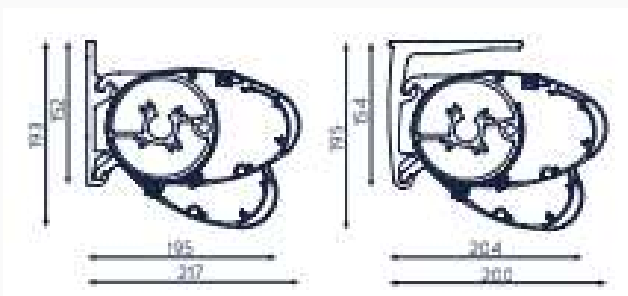

### B 5 0 XL

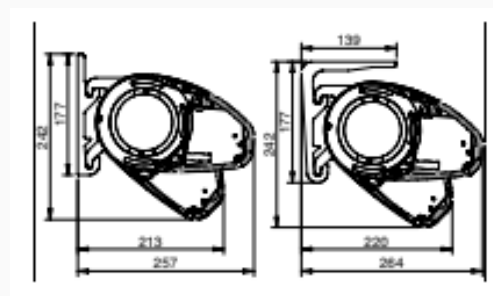

# SUN PROTECTION

## B 3 4

## B 3 4 X L

## B 4 0

The B34 is an economical screen available up to a maximum width of 6m. The maximum overhang is 3 m. This screen is equipped with a motor as standard (but can optionally also be equipped with a winch).

Thanks to the crossed articulated arms, the B34 XL makes it possible to have a large projection.

The B40 is an ideal awning for the project market. The design of the screen is based on the B35, but with a rounded design. There are two types available, one that is fixed directly to the wall (type I) and one that is mounted using special brackets approx. 10 cm from the wall (type K).

### B34 and B34 XL

- Large summer screen with limited width
- Articulated screen with a maximum width of 5 m
- Projection up to 3 m

### B40

- Articulated arm with 4 cables
- Ideal for the project market
- Available in 2 mounting types

## PHOTOGRAPHIES:

B 3 4

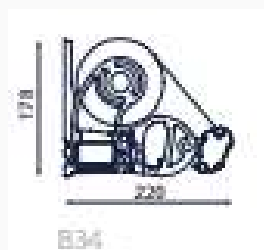

B 3 4 X L

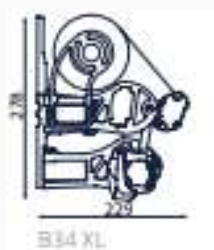

B 4 0

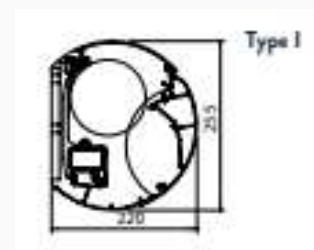



# SUN PROTECTION

## TWISTOR

### B 2 0

### B 2 1

The Brustor Twinstor creates shade wherever you want: you simply anchor the awning in the garden or on the terrace without the need for a wall or veranda. The closing cassette awnings protect the fabric and the mechanical components in the best possible way. The articulated arms can be operated with a Somfy remote control. For extra warmth and light on cooler evenings, you can add LED lighting and electric patio heating to the structure.

Looking for awnings for your balcony? The semi-closed B20 awning is designed for roof mounting and available with a 5° to 40° pitch. The B21 can even be mounted with an inclination of 20° to 60°, ideal for extra privacy and shade. With a compact height of 13.5 cm, the The cassette of these two awnings is ideal for installation under a balcony.

### Twinstor

- Self-supporting structure with 2 B25 awnings, also available in B25 Elite available
- The centre of attention on every terrace
- Free-standing awning
- Electrically operated arms
- 100% closed box awnings - up to 42 m<sup>2</sup> shading area

### B20 and B21

- Semi-closed awning
- Extension up to 3 m
- Maximum width 5.50 m

## PHOTOGRAPHIES:

### TWINSTOR

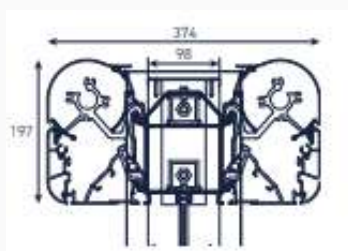

### B 2 0 Y B 2 1

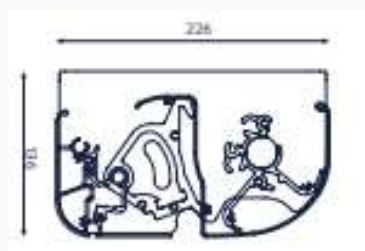

# SUN PROTECTION

## WINDBLOCKER

### B126

### B127 PERGOLA

Do you want to block the wind and prying eyes and create some side shade? Then choose the Brustor Wind Blocker. The stretched fabric can be fixed directly to the wall or to a pole. The integrated spring guarantees optimal fabric tension. The elegant protective box protects the fabric when it is rolled up and consists of a corrosion-resistant powder-coated extruded aluminium.

The B126 creates, so to speak, a shade roof on your rectangular verandas, conservatories and sloping glass surfaces. A unique option is the extendable telescopic extension, which shades up to 1.25 m in front of the veranda. Rolling the fabric upwards prevents leaves and dirt from getting in. Depending on the type of fabric, a veranda of up to 6 m extension / 5 m width / 19 m<sup>2</sup> area can be shaded. In a coupled version, the maximum width is doubled to 10 m and a surface area of 38 m<sup>2</sup> (Acrylic) or 36 m<sup>2</sup> (Soltis).

The B127 pergola is a free-standing structure supported by side rails, 2 posts and a wall bracket. It is the ideal pergola for your terrace. The B127 is also extremely suitable for a restaurant terrace. Under the fabric surface of up to 22 m<sup>2</sup>, your customers have a place where they can fully relax, in the shade or in the sun.

#### Windblocker

Terrace windbreak

- Provides additional privacy
- Manual operation
- Wall or pole mounted

#### B126 y B127 Pergola

- Telescopic extension up to 1.25 m possible
- Up to 19 m<sup>2</sup> of shade, coupled up to 38 m<sup>2</sup>
- Pergola with self-supporting structure
- Remote-controlled motor
- Lighting at the support posts
- Maximum width of 6 m
- Projection up to 5 m

## PHOTOGRAPHIES:

### WINDBLOCKER



### B126 Y B127 PERGOLA

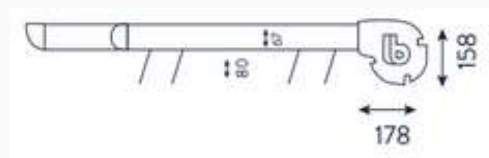

# SUN PROTECTION

## B127 VERANDA

## B128 PERGOLA

## B128 VERANDA

The B127 Veranda is a flexible veranda awning that not only completely shades irregularly shaped verandas with shade, but also provides protection up to 1 m beyond the sides. Optionally, a telescopic extension of up to 1.25 m at the front can create even more shade. Depending on the type of fabric, this motorised awning covers a veranda up to 6 m wide or 5 m long with a maximum shaded area of 22 m<sup>2</sup>.

The B128 pergola is a minimalist aluminium patio awning with a sun and rain resistant roof based on ZIP screen technology. Thanks to the effective tensioning of the side guides, the fabric always remains taut and is highly wind resistant, i.e. without wind edges. The uniform surface and the minimum 15 cm/m ensures that every drop of rain runs off quickly into the invisible gutter integrated into the front profile.

Like the B128 pergola, the B128 veranda has a tensioned fabric based on ZIP screen technology. In the B128 veranda it is exclusively solar shading. The posts have been replaced by brackets that are fixed directly to the roof of the conservatory. On these brackets, the guides are fixed.

### B127 VERANDA

- Motorised blinds for terraces
- Extension 1,25 M.
- Flexibility advantage

### B128 PERGOLA y B128 VERANDA

- Light but sturdy structure
- Perfect dosage of light, shade and ventilation
- Water drainage through the support posts
- Optional LED lighting on posts, side railings and support beam
- For better water drainage, the following options are available 1 adjustable bollard
- Optional motorised awning up to 1 m with solar cell + battery
- Extremely wind resistant terrace awning
- Perfect dosage of light and shade

## PHOTOGRAPHIES:

### B127 VERANDA



### B128 PERGOLA Y B128 VERANDA



# SUN PROTECTION

## TOPSCREEN

## ZIPSCREEN

## B1200 ZIP

The Topscreen is an awning for horizontal and inclined glazed areas, skylights, compact verandas and conservatories. The combination of the Brustor spring system with ZIP Screen technology keeps the fabric taut at any height, even at 6 Beaufort. Total blackout is possible with the Blockout Lunar blackout fabric.

The ZIP B1085, B1100 and B1350 are extremely windproof, sun and insect resistant screens. The unique zip system keeps the fabric in the side guide at any height. The ZIP screen meets the highest wind rating. You have the choice between a round or a square casing depending on the height of the screen. The maximum fabric surface of the ZIPscreen can be up to 18 m<sup>2</sup> above. The ZIPscreen is also available in a docked version.

The B1200 is completely integrated into the hollow wall and flows seamlessly from the wall to the window. There are no disturbing elements to obstruct the view. Fully in accordance with the Brustor ZIPscreen Principle, the screen automatically slides down windproof through the side guides. The heavy bottom bar holds the fabric firmly in the side guides. ZIPscreens are the guarantee for wind, sun and insect resistant window fabric. The B1200 can be supplied in a range of screen fabrics. The fabric roll can be replaced in a very simple way.

### TOPSCREEN

- Compact conservatory awning with ZIP Screen Technology
- Suitable for horizontal and angled glazing
- Resistant to 6 Bft
- High quality sun protection or blackout fabric

### ZIPSCREEN Y B1200 ZIP

- Wind resistant awnings
- Insect repellent fabric
- Resistant to high wind speeds
- Round or square casing
- Mesh box and side rails can be incorporated as an integral part of the screen box
- Bottom bar disappears into screen box
- Screen to be installed together with windows
- Easy access to roller shaft and fabric

## PHOTOGRAPHIES:

### TOPSCREEN



### ZIPSCREEN Y B1200 ZIP



# SUN PROTECTION

## HOEKSCREEN

## KABELSCREEN

## STANDAARD SCREEN

In terms of technology, the Brustor angle screen is based on the strong and windproof B1350 C surface screen with straight housing. It is a fully automatic widescreen that slides at right angles and slides evenly up and down on the side rails. There are no interfering profiles in the corner itself. Ideal, therefore, for situations where the glass window without support profile meets in the corner. This guarantees a wide unobstructed view outside while, on the other hand, shade is obtained evenly in the living area. It can be controlled by an LT, RTS or IO electric motor. With the latter, this shade can be operated from the smartphone. The motor is always on the longer side.

In this economical version of the standard screens the side guides have been replaced by elegant steel cables. Due to their aesthetic appearance, you can use cable screens not only outdoors, but also indoors as decorative roller shutters.

B1085 and B1100 sit in a compact and elegant housing depending on the height of the window. The maximum width is 4 m for a single blind and 7.20 m for an attached blind. The maximum height of the screen is

4 m. Thanks to the small and unobtrusive housings, Brustor Screens blend perfectly into any façade. As an option, the screens can be in any RAL colour. In addition to the standard screen, a recessed version is also available.

### HOEKSCREEN

Ideal for corner constructions where windows are glazed against each other without a corner profile.

### KABELSCREEN y STANDAARD SCREEN

- Elegant and functional
- With elegant steel cables
- For indoors and outdoors
- Vertical blinds
- Maximum privacy
- With integrated motor
- Maximum width of 4 m

## PHOTOGRAPHIES:

### HOEKSCREEN



### KABELSCREEN y STANDARD SCREEN



# SUN PROTECTION

## B2100 UITVALSCHERM

The Brustor B2100 is a storm-proof drop screen with fixed arms. A locking aluminium cassette protects the fabric and the mechanical parts from inclement weather conditions. Thanks to a built-in spring system the fabric always remains under tension. The drop screen is a maximum of 5 m wide and linked to 6 m. As an option, you can replace the standard motor with hand crank.

### B2100 UITVALSCHERM

- Storm-proof drop-down display
- Tilt up to 90° or 135
- Maximum width 5 m, looped up to 6 m

### THE SUCCESS OF A FAMILY BUSINESS

Brustor is originally a family business that has been producing only high quality patio covers, awnings and screens for decades. for decades. Innovation, quality and technology are still the key to our success. our success. Another advantage is our many years of experience, which enables us to respond perfectly to every demand.

### LEADER IN EUROPE

Since its creation, Brustor has become an internationally strong player in the awning market. All in-house production takes place in the new, 50,000 m<sup>2</sup> large production hall in Gullegem, from where we export to 30 countries. Also our warehouse continues to grow, which enables us to deliver orders at lightning speed. Our greatest capital is our employees. Skilled people who think and act in a progressive way. act. Whether they handle the machines with the utmost

Whether they are involved in commercial tasks, the realisation of installations or the research of innovative techniques, they are experienced and motivated. All of them are experienced, motivated and customer-focused people who consider quality to be paramount.

### STATE-OF-THE-ART MACHINERY

The best products require a well-oiled machine park that handles the latest production and assembly techniques. Our state-of-the-art, personnel-controlled machinery excels in precision. High Productivity is guaranteed. Thanks to a modern paint plant system, we can produce any colour.

## PHOTOGRAPHIES:

### B2100 UITVALSCHERM





